

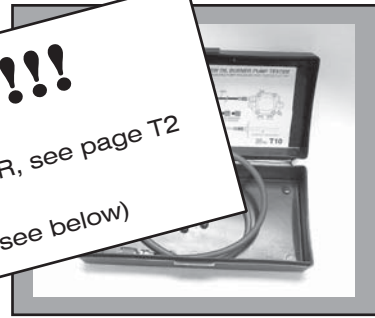

**"PRESSURE-VIEW" OIL BURNER PUMP TESTER**

- ▶ Quick-connect fittings
- ▶ Brass construction
- ▶ Fits popular 3/16"
- ▶ Stainless steel liquid filled gauge
- ▶ Easy-to-follow instructions

**SUPERCEDED!!!**

by the **NEW T11** "FITZ-ALL" TESTER, see page T2  
 (parts for the T10 are still available, see below)



 No. T10

**T10 TESTER PARTS**

 No.	Description
T10-3	Replacement adaptor fittings for T10 tester, 3/16" X 1/4" flare, Pkg. of 2
T10-4	Replacement rubber quick-connect seats (gaskets) for T10 tester, Pkg. of 12
T10-5	Replacement hose set (2 color coded hoses) with fittings for T10 tester
S100-280	Replacement Liquid Filled 0-300 PSI Pressure Gauge for T10 tester

**"VACUUM-VIEW" SUCTION LINE ANALYZER**

- ▶ Thick clear tubing does not collapse from vacuum
- ▶ All brass with stainless steel tubing clamps
- ▶ Fits popular 3/8" and 1/2" suction line fittings
- ▶ Stainless steel liquid filled gauge, range 0 - 30" Hg
- ▶ Easy-to-follow instructions - rugged carrying case



 No. T15

Analyze suction line problems (ie. air leaks, restrictions, dirt, etc.) using this clear tubing service tool. Vacuum gauge liquid dampens pulsation allowing precise measurement and protects gauge from hydraulic shock damage. Actually see what's happening inside that problem suction line! Complete instructions and "Service Truck Tough" carrying case.

**OIL BURNER PUMP VACUUM TESTER**

 No.	Description
T15	Complete suction line analyzer w/case, adaptor fittings and instructions
T15-1	Replacement adaptor fittings for T15 tester, 1/2" suction line, Pkg. of 2
T15-2	Replacement clear tubing w/clamps for T15 tester
S100-290	Replacement Liquid Filled 0-30" Hg. Vacuum Gauge for T15 tester



For testing RIELLO pumps see pages T2 & T3

Please order by  No.

rev. 1-1-09

**T1**



Westwood

**"FITZ - ALL" OIL BURNER PUMP TESTER**

**The first NEW design in pump testers in over 25 years!**

Tests: Standard burners  
 Beckett w/cover (Burnham AFG, NX, etc.)  
 Riello

- ✓ Angle connector for **hard to reach** connection to **Beckett** pumps
- ✓ Quick-connect fittings have built-in seals and require only **finger tightening**
- ✓ Super **flexible** micro diameter color coded high pressure hoses
- ✓ Fits popular 3/16" flare nozzle line fittings - comes with adaptors for **Riello** pumps (European thread) and 1/4" flare nozzle line fittings
- ✓ **Stainless steel liquid filled** gauge with **0 - 300 PSI** range
- ✓ **Rugged** carrying case with easy-to-follow **instructions**

**CONNECTS EASILY TO WHAT'S OUT THERE!**

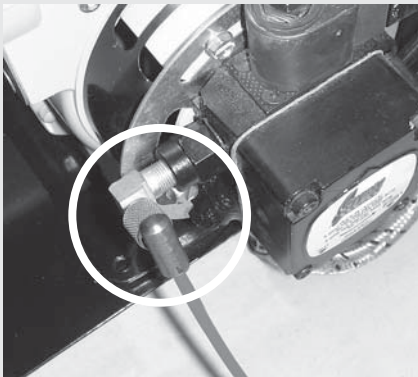

**STANDARD**  
 (90° or straight flare fitting in nozzle port)

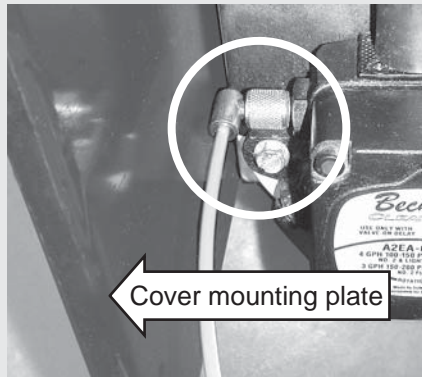

**BECKETT with cover**  
 (hard to reach pump fitting due to cover mounting plate)

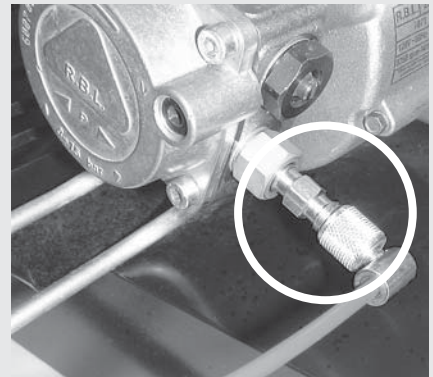

**RIELLO**  
 (European thread adaptor fits in pump bleeder port)

Choose between pressure measurement and cut-off test\* with just the turn of the knob - no disconnecting! Fits standard 3/16" flare nozzle line fittings. Includes adaptors for 1/4" flare nozzle line fittings and for Riello pumps (European threads). Super flexible small diameter high pressure tubing and quick-connect fittings allow fast hook-up with just finger tightening. "Service Truck Tough" carrying case with complete instructions.

\* Not used for checking cut-off on Riello pumps

**"FITZ-ALL" OIL BURNER PUMP PRESSURE & CUT-OFF TESTER**



No. T11

No.	Description
T11	Complete oil burner pump tester w/case, adaptors and instructions
T11-3	Replacement adaptors for T11 tester, (2) 3/16" X 1/4" flare, (1) Riello
T11-4	Replacement rubber quick-connect seals (gaskets) for T11 tester, Pkg. of 12
T11-5	Replacement hose set (2 color coded hoses w/fittings) for T11 tester
S100-280	Replacement Liquid Filled 0-300 PSI Pressure Gauge for T11 tester

**T2**

# RIELLO PUMP TESTERS

The first tester specifically designed for the Riello pump! Quick-Connect European thread adaptors mount easily on the pump with just finger tightening. The 24" color coded flexible lines allow the tester to be placed in any convenient location for remote reading of the pump pressure and vacuum.

- ▶ Quick-connect European thread fittings require only finger tightening
- ▶ Liquid Filled gauges dampen pulsation - no hydraulic shock
- ▶ "Service Truck Tough" case

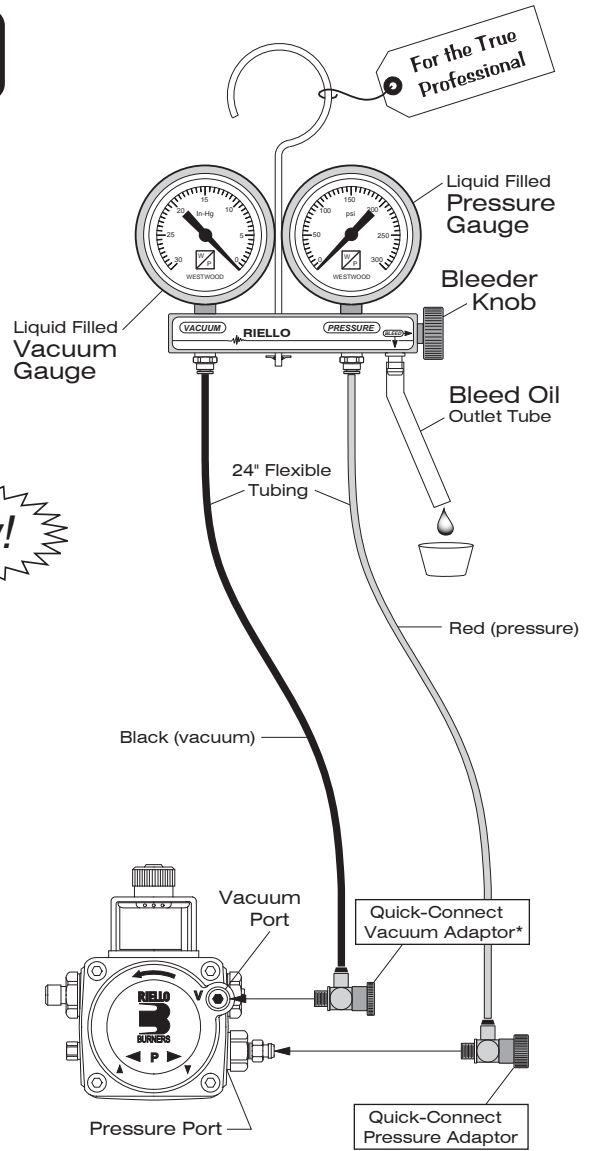
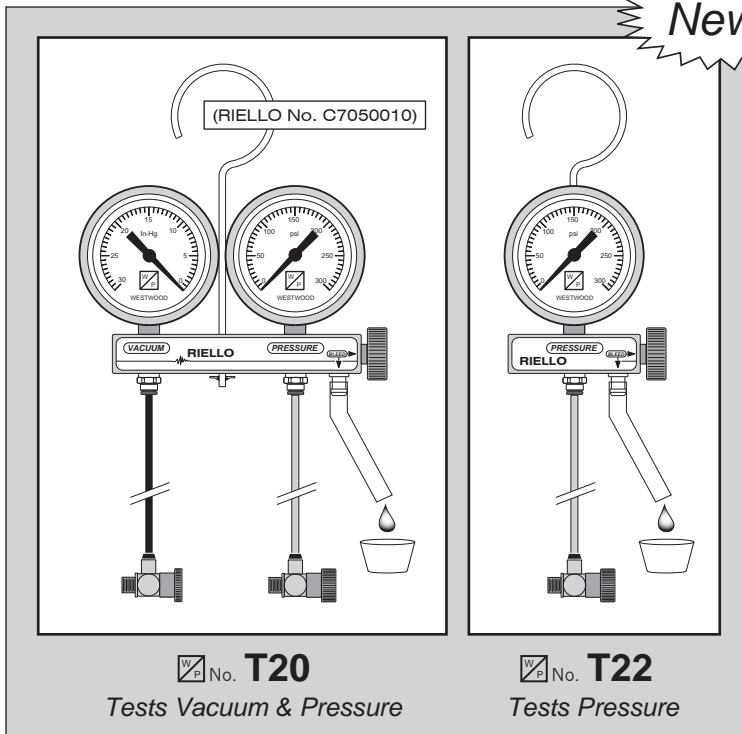

\*Can also be used on older pumps that have the vacuum port on the side of the pump.

W/P No.	RIELLO No.	Description
T20	C7050010	Complete RIELLO tester with case, liquid filled gauges, Quick-Connect adaptor fittings
T20-10	-	Replacement hose set (1 ea. Red and Black) for T20 tester
T20-12	-	Replacement "O" ring for T20 and T22 tester Quick-Connect adaptors, Pkg. of 6
T20-14	-	Replacement Nylon washer for T20 and T22 tester Quick-Connect adaptors, Pkg. of 6
T20-16	-	Replacement "Drip Cap" for T20 and T22 tester Quick-Connect adaptors, Pkg. of 6
T20-18	-	Replacement carrying case for T20 tester
T22	-	RIELLO pressure tester with case, liquid filled gauge, Quick-Connect adaptor fitting
T22-10	-	Replacement hose (Red) for T22 tester
T22-18	-	Replacement carrying case for T22 tester
S100-285	-	Replacement Liquid Filled 0-300 PSI pressure gauge (2-1/2" face) for T20 and T22
S100-295	-	Replacement Liquid Filled 0-30" Hg. vacuum gauge (2-1/2" face) for T20

Take a look ...

For testing SUNTEC & WEBSTER pumps see pages T1 & T2

Please order by No.

rev. 1-1-09

Westwood

**"VAC-PROBE" OIL LINE ACCESS PORT**

Allows access to oil lines without opening or disconnecting fittings. Installed in place of the center bolt on the line filter it allows not only vacuum tests to be made quickly and neatly, but also affords easy access to the fuel system for pump priming and connection of a temporary oil line (run outs). One piece solid steel construction.

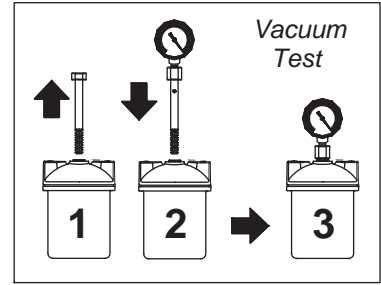

- ▶ Quickly and neatly access fuel system without disconnecting fittings!
- ▶ Liquid filled gauge dampens pulsation allowing precise measurement and protects gauge from hydraulic shock damage
- ▶ Models available for all popular heating oil line filters

 No.	Description
T25	Vac-Probe Kit; (1) Vacuum gauge, (4) Vac-Probes-1 ea.
T25-1	Vac-Probe w/gauge for small General 1A style filter
T25-2	Vac-Probe No. T25-1, less gauge
T25-3	Vac-Probe w/gauge for large General 2A style filter
T25-4	Vac-Probe No. T25-3, less gauge
T25-5	Vac-Probe w/gauge for Fullflo FB4, FB6, FB8, FB10
T25-6	Vac-Probe No. T25-5, less gauge
T25-7	Vac-Probe w/gauge for Firomatic C-40, C-50
T25-8	Vac-Probe No. T25-7, less gauge

STAINLESS STEEL LIQUID FILLED GAUGES

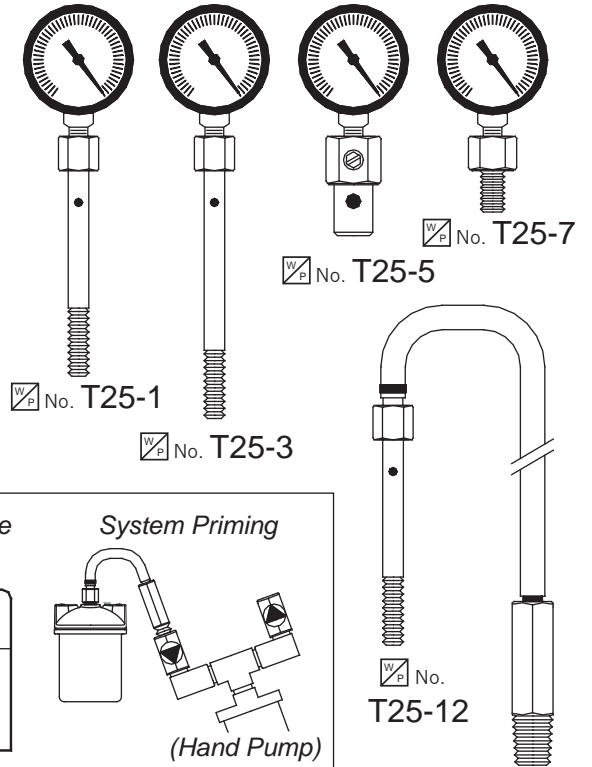

 No.	Vac-Probe Run Out Adaptor*
T25-12	For small General 1A style filter
T25-14	For large General 2A style filter
T25-16	For Fullflo FB4, FB6, FB8, FB10 filters
T25-18	For Firomatic C-40, C-50 filters

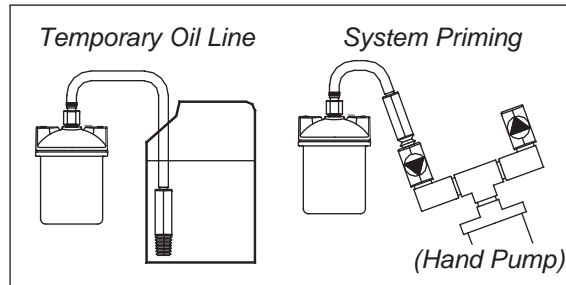

\*Vac-Probe w/48" flexible hose connected to a heavy weight 3/8" NPT hand pump connection adaptor. Adaptor easily connects to a hand pump, or serves as a hose end weight when drawing oil from a can.

Westwood

**"FLO-THRU"**

Sliding Handle

**BLEED WRENCH**

- ▶ Quickly and neatly bleed oil burner pumps
- ▶ Handle slides side-to-side for easy bleeding

 No.	Description
T28	Bleed Wrench with 12" hose
T28-2	Replacement hose, Pkg. of 6

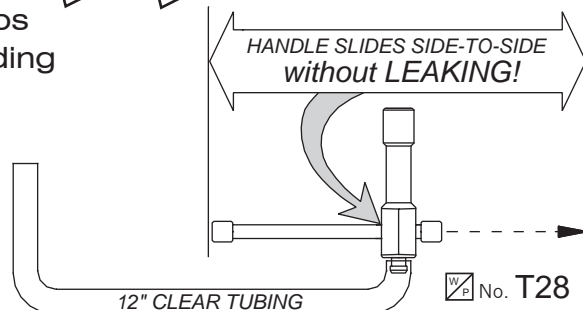

Westwood

**"EASY ANGLE" PRESSURE & VACUUM HAND PUMPS**

Hand operated piston pumps with built-in check valves for use with liquids and air. Ideal for clearing plugged oil lines, priming pumps, transferring liquids, and adding chemicals to boilers.

Now with Genuine



**CHECK VALVES!**

- ▶ Unique "EASY ANGLE" 120° valve angle makes connections easy
- ▶ Two Sizes - Standard and High Capacity
- ▶ High Capacity model gives 50% more volume per stroke!
- ▶ Exclusive center port for installation of a compound gauge allows monitoring of the system pressure and vacuum during operation
- ▶ Comfortable "T" handle and protective vinyl sleeve on barrel
- ▶ Quick-connect hose set attaches to hand pump using no tools! (Same, no tools needed connection to all popular hand pumps)

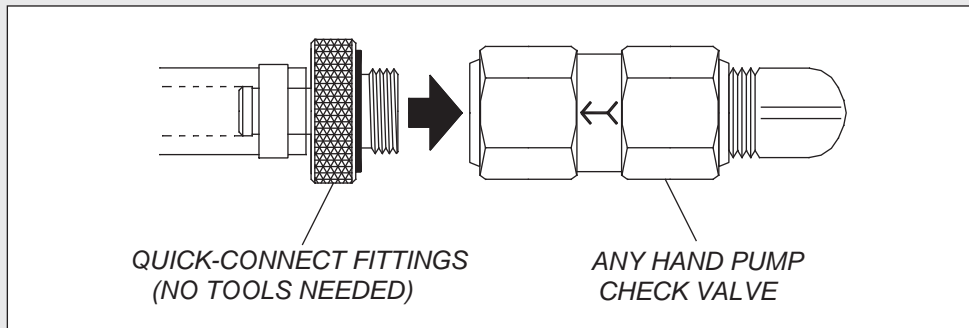

No. T30-4

QUICK-CONNECT FITTINGS & HOSE SET



No. T30  
STANDARD

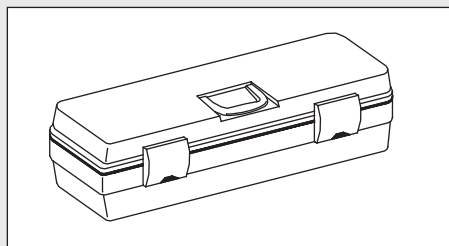

No. T30-6

CARRYING CASE FOR T30 & T30-4



No. S100-402

CENTER PORT COMPOUND GAUGE  
30" Hg. - 150 PSI (2" FACE, 1/8"- NPT)







No. T30-1  
HIGH CAPACITY

No.	Description
T30	Standard hand pump w/ 1/8"- NPT center access port
T30-1	High capacity hand pump w/ 1/8"- NPT center access port
T30-4	Quick-connect, no tools needed fittings and hoses set
T30-6	Plastic carrying case for T30 hand pump, fittings and hoses
T30-8	"O" ring for T30, -1 and all 1-1/4" barrel pumps, Pkg. of 2
S100-402	Compound pressure-vacuum gauge for center access port
S230	Replacement check valve, 3/8" NPT, genuine Firomatic?

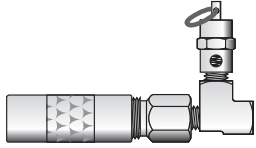
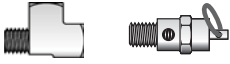
Westwood

**CO<sub>2</sub> BLOW OUT GUNS & KITS**FOR QUICKLY CLEARING PLUGGED LINES  
ALL BRASS CONSTRUCTION

W/P No.	Reference No.	Description & Representative Picture
T32	ML-3	CO <sub>2</sub> blow out gun for clearing clogged oil lines and instrument transmission lines. Built-in check valve allows spent cartridge to be removed without loss of pressure. 
T32-10	ML-3-150	CO <sub>2</sub> blow out gun with built-in safety valve. Limits pressure at outlet of gun to 150 PSI. Since CO <sub>2</sub> cartridges produce approximately 800 PSI, the additional pressure is relieved should a severely restricted line be encountered. 
T32-11	ML-3-150-UPG	150 PSI safety valve upgrade kit for blow out gun (Relief valve and angle adapter, 1/8"-NPT) 
T32-15	ML-3-P1000	CO <sub>2</sub> blow out gun with 1,000 PSI pressure gauge. Accurately monitors pressure in the line during clearing. Constant pressure indicates line is blocked; falling pressure means blockage is moving; no pressure means line is clear. Complete kit includes blow out gun with gauge, box of CO <sub>2</sub> cartridges, plastic carrying case, and instructions 
T32-16	ML-3-PQ	CO <sub>2</sub> blow out gun with Quick-Connect Kit for quickly connecting to different line sizes. Kit includes blow out gun with 1,000 PSI pressure gauge, quick-connect coupling, (1) ea. 3/8" & 1/2" compression connectors, (1) ea. 3/8" & 1/2" flare connectors, plastic carrying case, and instructions 
T32-20	QCK-1 Kit	Quick-Connect Fittings Kit (blow out gun not included). Contains quick-connect coupling, (1) ea. 3/8" & 1/2" compression connectors, (1) ea. 3/8" & 1/2" flare connectors 
T32-25	"O" rings	Replacement "O" ring for blow out gun, package of 6

 Take a look...
CO<sub>2</sub> CARTRIDGES on page T7

rev. 5-1-07

**T6**Please order by  No.



**Westwood**  
**CO<sub>2</sub> CARTRIDGES**

 No.	Reference No.	Description
T32-30	CO <sub>2</sub> Cartridges	CO <sub>2</sub> cartridges, 8 gram, 800 PSI, Box of 10*

\* 40 boxes of 10 cartridges per case

**Westwood**  
**FLAME MIRRORS & PILOT LIGHTERS**

**Telescoping Handle**

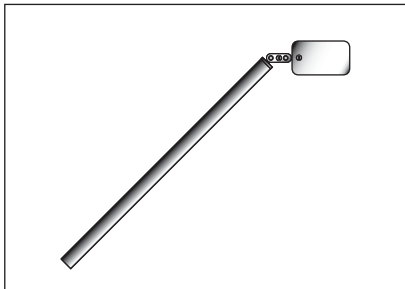

 No. T34-10

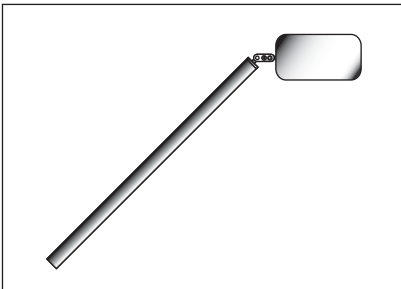

 No. T34-15

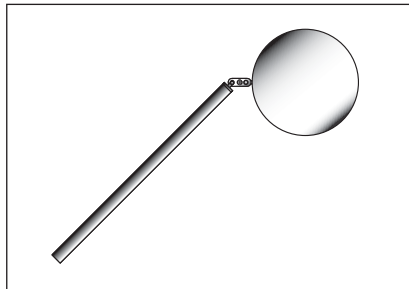

 No. T34-25

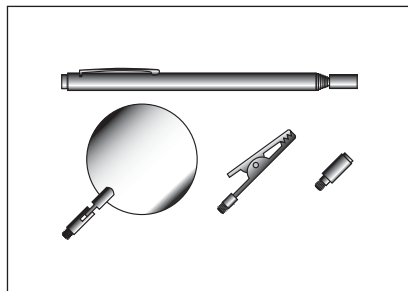



 No. T34-30



 No. T34-35



 No. T34-40

 No.	Reference No.	Description
T34-10	MR-1X2	1-1/4" x 2-1/8" telescoping rectangular flame mirror
T34-15	MR-2X3	2" x 3-3/4" telescoping rectangular flame mirror
T34-25	MR-4	4-1/4" diameter telescoping round flame mirror
T34-30	MK-3 Kit	26" telescoping tool with clip, magnet, and 2" mirror
T34-35	ML-26	26" telescoping pilot lighter
T34-40	12" Lighter	12" pilot lighter, plated handle, non-telescoping

Westwood is proud to introduce the **BRIGON** line of quality combustion test equipment. One of the world's oldest and most respected manufacturers of test equipment for the heating industry, **BRIGON** offers advanced European technology at an affordable price. And while the **BRIGON** name may be unfamiliar in North America, the products will be immediately recognized as interchangeable with test equipment widely used here today.

Westwood

### OIL BURNER COMBUSTION TEST KIT

# BRIGON

#### T35 TEST KIT CONTAINS:

- CO<sub>2</sub> Indicator
- CO<sub>2</sub> Indicator sampling assembly
- Stack thermometer - 900° F
- Draft gauge & sampling hose assembly
- Smoke tester with smoke test paper and smoke scale
- Efficiency calculating slide rule
- Steel carrying case



 No. T35

Westwood

### OIL BURNER CO<sub>2</sub> INDICATOR KIT

# BRIGON

#### T36 TEST KIT CONTAINS:

- CO<sub>2</sub> Indicator
- CO<sub>2</sub> Indicator sampling assembly
- Efficiency calculating slide rule
- Carrying case



 No. T36

 No.	Description	Replaces Bacharach
T35	<b>BRIGON</b> Oil burner combustion test kit with carrying case	10-5022
T35-1	T35 kit with smoke tester & stack thermometer manufactured by Westwood	10-5022
T36	<b>BRIGON</b> CO <sub>2</sub> indicator kit with carrying case	10-5000
T36-2	<b>BRIGON</b> CO <sub>2</sub> indicator only	11-7032
T36-10	Replacement sampling assembly for <b>BRIGON</b> and Bacharach CO <sub>2</sub> indicator	11-7029
T36-12	Replacement bulb only for <b>BRIGON</b> and Bacharach sampling assembly	11-0120
T36-14	Replacement red (in) check valve for <b>BRIGON</b> and Bacharach sampling assembly	11-0138
T36-15	Replacement green (out) check valve for <b>BRIGON</b> and Bacharach sampling assembly	11-0127
T36-16	Replacement rubber hose for <b>BRIGON</b> and Bacharach sampling assembly	11-0119
T36-18	Replacement filter tube w/yarn for <b>BRIGON</b> and Bacharach sampling assembly	11-0130
T36-20	<b>BRIGON</b> Efficiency calculating charts	-

Westwood

**SMOKE TESTER - POLYCARBONATE BARREL**

- ▶ Virtually unbreakable Polycarbonate barrel
- ▶ Hardware all Brass and Stainless Steel
- ▶ Sampling tube hooks into smokepipe
- ▶ Fits into **BRIGON** and Bacharach cases
- ▶ Lifetime silicone lubrication

POLYCARBONATE  
no dents, no corrosion!

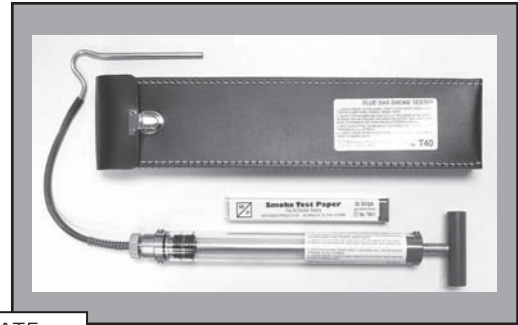

No. T40

Reliable and durable instrument for measuring the smoke number of a flue gas sample. Flue gas is taken from an opening in the flue pipe and drawn through the smoke test paper mounted in the tester. Comparison of the test paper with the smoke scale determines the smoke scale number.

*INCLUDES : SMOKE TESTER, SMOKE TEST PAPER, SMOKE SCALE, CARRYING CASE*

Westwood

**UNIVERSAL SMOKE TEST PAPER**

- ▶ Precut strips for use in all smoke testers
- ▶ Includes smoke scale
- ▶ Sturdy dust & dirt proof plastic package



No. T40-1

*Pkg. of 50 strips  
with smoke scale*

**BRIGON SMOKE TESTER**

- ▶ Corrosion proof construction
- ▶ Fits into **BRIGON** and Bacharach cases

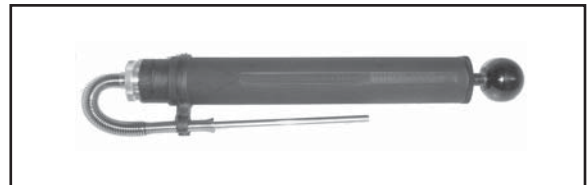

No. T41

No.	Description	Replaces Bacharach
T40	Westwood polycarbonate barrel smoke tester kit with carrying case	21-7006
T40-1	Westwood Universal precut smoke test paper and smoke scale, Pkg. of 50 strips	21-0019
T41	<b>BRIGON</b> smoke tester	21-7006
T41-1	<b>BRIGON</b> smoke test paper, Pkg. of 40 papers	21-0019
T41-2	<b>BRIGON</b> smoke scale	21-0018
T41-5	<b>BRIGON</b> smoke tester lubricant	-

Westwood

**STAINLESS STACK THERMOMETER**

- Stainless steel construction
- 3" Face - 6" Insertion Probe
- Includes stack mounting clip
- Fits BRIGON and Bacharach cases
- Range: 200° - 1000° F



No. T42

**BRIGON**

**STACK THERMOMETER**

- Stainless steel construction
- Fits BRIGON and Bacharach cases
- Range: 0° - 900° F



No. T43

**BRIGON**

**DRAFT GAUGE**

- ▶ Precision instrument for accurate readings
- ▶ Tough, lightweight construction
- ▶ High visibility scale, -.25" to +.05" WC
- ▶ Requires no leveling for accurate readings
- ▶ 9' flexible hose with 5" draft probe

This precision instrument measures draft with accuracy not attainable with pocket draft or styrofoam ball and tube type gauges. Its high strength case stands up to daily use and will not damage the way Bakelite cases do.



No. T45

Westwood

**CO<sub>2</sub> INDICATOR SERVICE PARTS & FLUID**

FOR  
**BACHARACH & BRIGON**  
TESTERS



No. T50-2, -5



No. T50-3

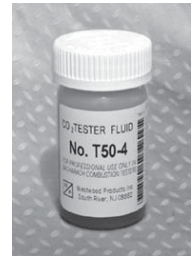

No. T50-4

No.	Description	Replaces Bacharach
T42	Westwood stainless steel stack thermometer	12-7014
T43	<b>BRIGON</b> stack thermometer	12-7014
T45	<b>BRIGON</b> precision draft gauge	13-7019
T45-1	Replacement hose & probe for <b>BRIGON</b> draft gauge	-
T50-2	Westwood CO <sub>2</sub> Indicator Repair Kit, (1) Bottle CO <sub>2</sub> Fluid, Valve Plunger Seal, Top Gasket, Diaphragm, Screws, Filtering Material, Nitrile Gloves, for Bacharach	11-7052
T50-3	Westwood CO <sub>2</sub> Indicator Recharging Kit, (2) Bottles CO <sub>2</sub> Fluid, Top Gasket, Screws, Filtering Material, Nitrile Gloves, for Bacharach	11-7047
T50-4	Westwood CO <sub>2</sub> Indicator Fluid, (1) Bottle, for Bacharach and <b>BRIGON</b>	-
T50-5	Westwood Repair Kit for <b>BRIGON</b> CO <sub>2</sub> Indicator, (1) Bottle CO <sub>2</sub> Fluid, Valve Plunger Seal, Top Gasket, Diaphragm, Screws, Filtering Material, Nitrile Gloves	-

Westwood

**OIL BURNER IGNITION TRANSFORMER TESTER**

- ▶ Safely tests from the transformer's primary side
- ▶ Transformer remains on the burner for testing
- ▶ Detects early stages of transformer breakdown
- ▶ Easy access built-in fuse protects meter
- ▶ Simple, easy-to-read meter
- ▶ Plugs into 120 volt outlet (ie. trouble light)
- ▶ "Service Truck Tough" with high impact case

Test standard iron core 10,000 volt oil burner ignition transformers quickly and safely with this rugged, easy-to-use tester. All testing is done from the primary side of the transformer avoiding contact with the high voltage terminals. Tests transformer while mounted right on the burner. (Note: Not for testing solid state igniters)



 No. T60

Westwood

**CAD CELL RELAY & EYE TESTER**

- ▶ Tests primary control and eye right on the burner
- ▶ Simple, easy-to-read and understand ohmmeter
- ▶ Built-in flame simulators for all popular controls
- ▶ "Service Truck Tough" with high impact case

Test both cad cell primary control and flame detector eye simultaneously without removing components from the burner. Built-in flame simulators for all popular controls insure accurate diagnosis and testing.



 No. T70

Westwood

**"AMP-MASTER" THERMOSTAT CIRCUIT METER**

- ▶ Accurately measures thermostat control circuit draw to correctly adjust heat anticipator setting
- ▶ Meter dial matches T87F heat anticipator scale
- ▶ "Service Truck Tough" with high impact case

Precisely measures the thermostat control circuit current to allow correct setting of the heat anticipator. Avoids repeat service calls to remedy short cycling or override problems. Connects at either the thermostat or relay.



 No. T80

 No.	Description
T60	Standard 10,000 volt oil burner ignition transformer tester
T70	Cad cell primary control and flame detector eye tester
T80	"AMP-MASTER" thermostat heat anticipator meter

Westwood

**"EASY ACCESS" PRESSURE TESTER**

0 - 100 PSI PRESSURE GAUGE • ALL BRASS CONSTRUCTION

**FOR LEAK TESTING TANKLESS COILS AND PRESSURE TESTING NEW PIPING**

The ideal tester for checking tankless coils for leaks, and pressure testing new piping of all types prior to building code inspections. Easily connects to any convenient garden hose thread (ie. boiler drain valve, wash tub faucet, etc.) without disturbing any fittings in the system. Built-in Schrader valve allows system pressurization with just a simple bicycle pump. Comes in a rugged, "Service Truck Tough" high impact case.

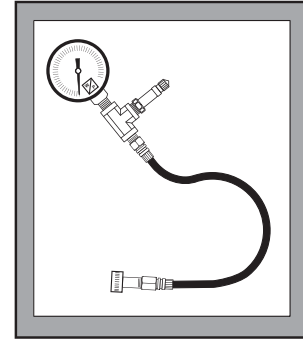
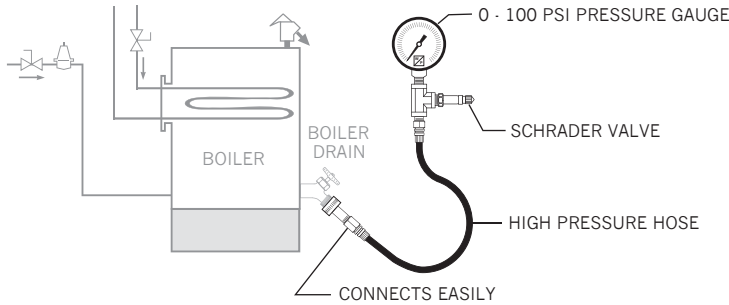

No. T90

Westwood

**GAS PRESSURE TESTER**

- ▶ Precision 0-15" WC "EZ Read" gauge with color coded dial for natural and L. P. gas
- ▶ 36" flexible hose with 1/8"- NPT brass adaptor
- ▶ "Service Truck Tough" with high impact case

For setting pressure of natural and L. P. gas appliances without the troublesome inconvenience and mess of water filled manometers. Gauge is precision diaphragm type with a 2-1/2" color coded "EZ Read" dial.



No. T91

Westwood

**"PILOT PUFFER" LINT & DUST BLOWER**

- ▶ Cleans hard-to-reach gas pilot burners and orifices
- ▶ Durable, rust proof 11" brass air tube
- ▶ Flexible, long life flexible rubber bulb

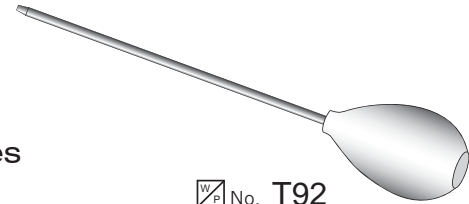

No. T92

No.	Description
T90	"EASY ACCESS" tankless coil and piping pressure tester
T91	Gas pressure tester for natural and L.P. gas
T92	"PILOT PUFFER" gas pilot and orifice lint and dust blower

**SMOKE PRODUCTS**

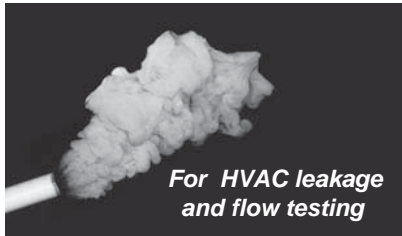

No. T95 (Series)

**LOW VOLTAGE TESTER**

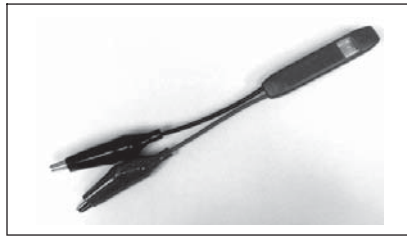

No. T100-10

**LINE VOLTAGE TESTER**

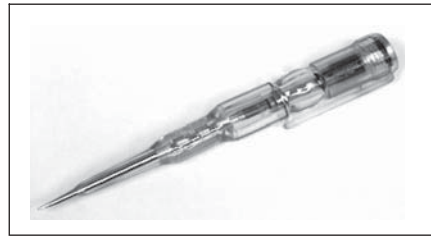

No. T100-15

**CORD & CLIP SET - 8' Long**

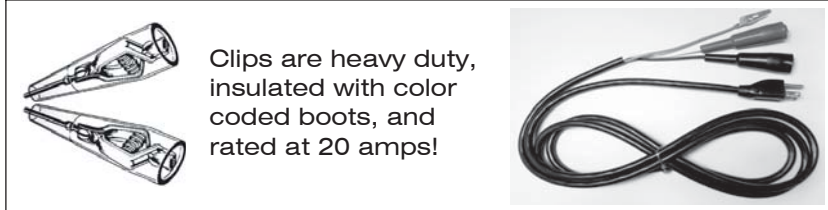

No. T100-50

**JUMPERS - Insulated & non-insulated**

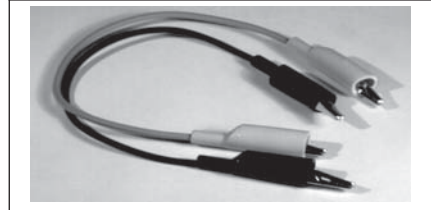

No. T100-70 through -84

**POCKET DIGITAL THERMOMETER**

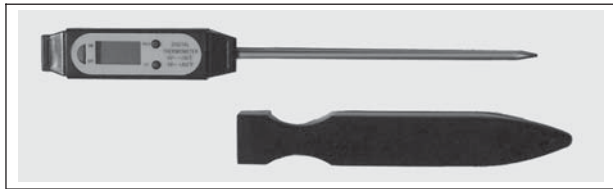

No. T100-120

**POCKET DIAL THERMOMETER**

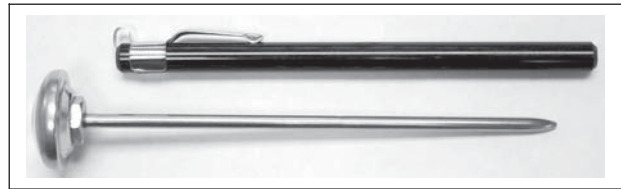

No. T100-125, -130

**SMOKE, VOLTAGE TESTERS, CORD & CLIP SET, JUMPERS, POCKET THERMOMETERS**

No.	Reference No.	Description
T95-20	-	Smoke emitter sticks, 20 seconds of smoke per stick, package of 20 sticks
T95-22	-	Smoke emitter pen with 6 wicks, 30 seconds of smoke per test, 60 tests per wick
T95-24	-	Smoke emitter pen refill wicks, package of 6 wicks
T95-26	-	Smoke emitter cartridges, 65 seconds of smoke, package of 10 cartridges
T95-28	-	Smoke emitter cartridges, 3 minutes of smoke, package of 5 cartridges
T100-10	LV Tester	Pocket low voltage tester, 5 - 50 VAC/VDC
T100-15	SD Tester	Pocket screwdriver line voltage tester, bright red light, 70 - 250 VAC
T100-50	7328	110 VAC/20A cord & clip set, 8' long cold weather flexible wire, w/ground wire clip
T100-70	JW-12	18 gage stranded wire jumper, non-insulated clips, 12" long
T100-72	JW-18	18 gage stranded wire jumper, non-insulated clips, 18" long
T100-74	JW-36	18 gage stranded wire jumper, non-insulated clips, 36" long
T100-80	IJW-12	18 gage stranded wire jumper, insulated clips, 12" long
T100-82	IJW-18	18 gage stranded wire jumper, insulated clips, 18" long
T100-84	IJW-36	18 gage stranded wire jumper, insulated clips, 36" long
T100-120	HDT 303K	Pocket digital thermometer, range: -58° to +302° F
T100-125	T-160	Pocket dial thermometer, range: -40° to +160° F
T100-130	T-220	Pocket dial thermometer, range: 0° to +220° F

Westwood

**NAS gauge™ NOZZLE ASSEMBLY SETTING GAUGES**

NO GUESSWORK • NO BLIND ADJUSTMENTS • NO BURNER REMOVAL

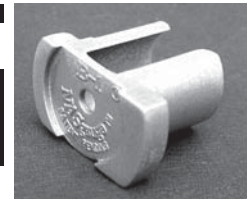

Proper **NOZZLE - COMBUSTION HEAD** relationship without removing the burner!

- ▶ Gauges are made of high impact polystyrene for long service life
- ▶ The B-1 & W-1 gauges are also used to set the electrode tips
- ▶ Available individually or in a complete kit containing all three gauges



**B-1 For Beckett**  
Models AF, AFG, SR,  
SF with "F" heads and  
SF II with "FBX" head

No. T100-202



**A-1 For Aero**  
Models HF-US, SV,  
SSV, F-AFC, HF-AFC

No. T100-204

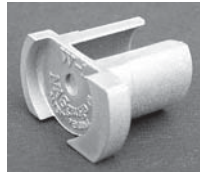

**W-1 For Wayne**  
Models EG-1, M-SR,  
EH-SR, EHA-SR

No. T100-206

No. T100-200 (Kit containing all 3 gauges)

**EASY TO USE:**

1. Slide *NAS gauge™* over the nozzle.
2. Insert nozzle assembly until it touches the combustion head.
3. Mark the position of the slide plate and remove *NAS gauge™*

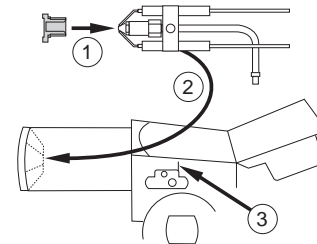

Westwood

**ELECTRODE GAUGE**



No. T100-220

Accurately sets electrode gap and placement from the nozzle based on nozzle spray angle.

Westwood

**ELECTRODE BENDERS**



No. T100-230

Pair of 5" long case hardened tools designed specifically for bending and adjusting electrode tips.

No.	Reference No.	Description
T100-200	NAS-ABW	NAS gauge™ nozzle assembly setting gauge kit, (3) gauges, instructions
T100-202	NAS-B1	NAS gauge™ nozzle assembly setting gauge for Beckett burners
T100-204	NAS-A1	NAS gauge™ nozzle assembly setting gauge for Aero burners
T100-206	NAS-W1	NAS gauge™ nozzle assembly setting gauge for Wayne burners
T100-220	Ignitor Gage	Electrode tip setting gauge
T100-230	TB-60	Electrode tip benders, 5" long case hardened steel, set of 2 benders

Westwood

# Coupler Popper™ with Coupler Aligner / Installer

This handy tool removes coupling ends stuck on the motor shaft from the pump side of the burner. No need to remove the motor! It also measures the proper dimension to cut a new coupling for a perfect fit, installs couplings through the pump side of the burner, and centers the pump end of the coupling for perfect alignment with the pump shaft. A real time saver that no service tech should be without.

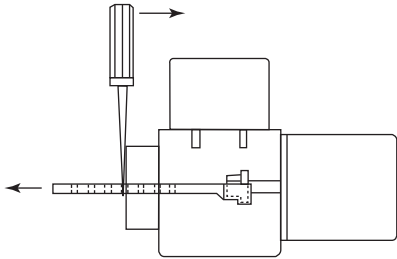

Removing stuck coupling end piece on motor shaft from pump side of burner

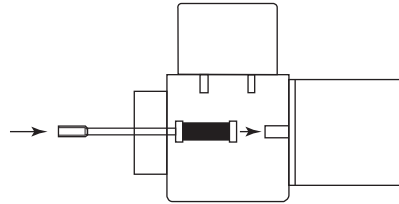

Using Aligner/Installer to install coupling on motor shaft from pump side of burner

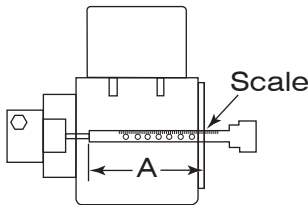

Measuring for proper coupling length (dimension "A" minus 13 marks on the Coupler Popper™ scale)

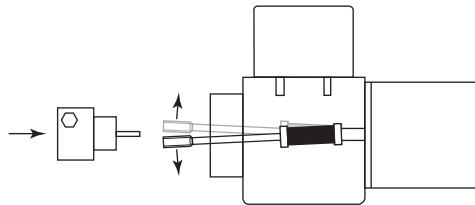

Using Aligner/Installer to center coupling end for perfect alignment with pump shaft

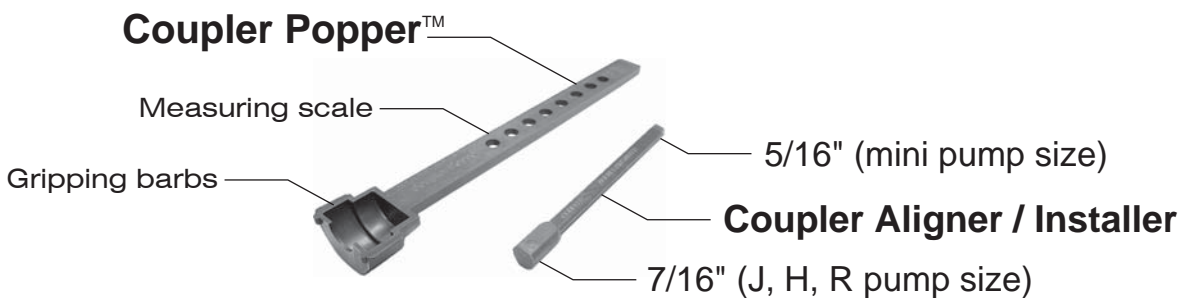

 No.	Ref. No.	Description
T100-300	CP-1	<b>Coupler Popper™</b> multi purpose coupling tool with Coupler Aligner/Installer

 Take a look . . .

COUPLING CUTTER on page T16

Please order by  No.

rev. 5-1-07

**T15**

Westwood

**COUPLING & GAUGE GLASS CUTTERS*****Use the right tool for the job!***

FIELD PROVEN • RUGGED CONSTRUCTION • QUALITY MATERIALS

**COUPLING CUTTER**

Cuts coupling shafts quickly and cleanly. No twisting or turning necessary. Cuts 1/8" to 1-1/4" O.D. rubber, polyethylene, neoprene, vinyl, PVC, etc. Reversible blade gives twice the blade life. Curved handles are easy on the hands.

 No. T100-310
**GAUGE GLASS CUTTERS**

Note: Always wear gloves and eye protection when working with glass

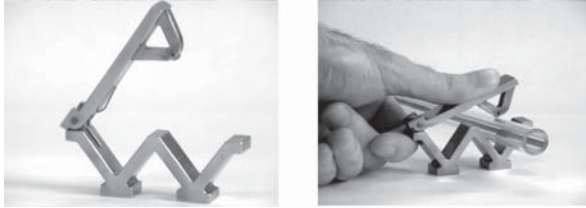
 No. T100-330

The only one recommended for cutting Red Line and High Pressure gauge glass. Cuts easily leaving a clean, straight edge. Just score and snap!

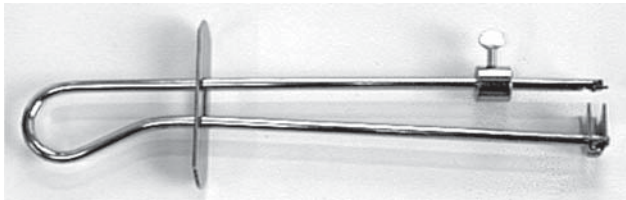
 No. T100-340

For cutting standard gauge glass. Cuts pieces as short as 1/2" or less. Set the stop to the desired length, squeeze the "trigger" and rotate the glass until it snaps cleanly in two.

 No. T100-350

For cutting standard gauge glass. Set the stop to the desired length, squeeze the handles and rotate the glass until it snaps cleanly in two.

 No.	Ref. No.	Description
T100-310	#35	Coupling cutter, heavy duty die cast metal handles, reversible blade
T100-312	#35 Blade	Replacement blade for T100-310
T100-330	WP-1	Gauge glass cutter for standard, Red Line, and High Pressure glass
T100-332	-	Replacement cutting wheel for T100-330
T100-340	#996	Gauge glass cutter with adjustable stop for standard glass
T100-342	#996-W	Replacement cutting wheel for T100-340
T100-350	RD-95	Gauge glass cutter for standard glass, adjustable stop, cast metal handles
T100-352	RD-95-W	Replacement cutting wheel for T100-350

 Take a look...

T100-370 PORCELAIN CUTTER also cuts gauge glass, see page T17

**T16**

rev. 5-1-07

Please order by  No.

Westwood

**PORCELAIN CUTTER**

*Use the right tool for the job!*

FIELD PROVEN • HEAVY DUTY CONSTRUCTION • HARDENED CUTTING WHEELS



No. T100-370

**NEW DESIGN! Easier to use!**

Replaces the old tool with external chain - no more wrapping the chain around! Powerful compound lever action snaps even the toughest oil burner porcelain. Hardened and tempered cutting wheels, sure-grip molded handles, hardened steel jaws, locking clasp, adjustable stop.

Also cuts standard gauge glass up to 3/4" in diameter!

*Note: Do not cut Red Line or High Pressure gauge glass with this tool. The stress exerted on the glass could lower the maximum pressure rating of the glass. Use instead the T100-330 gauge glass cutter shown on page T15.*

Westwood

**MASTER LINEMAN'S PLIERS & CRIMPER**



No. T200-10

*The Grandson of the famous Rajah™ Crimping Tool!*

A service tech's dream come true! All the features of lineman's pliers, plus the ability to cut, strip, and crimp ignition cable and terminals. Hand fitted and finished to make this professional quality tool a joy to use and a pleasure to look at.

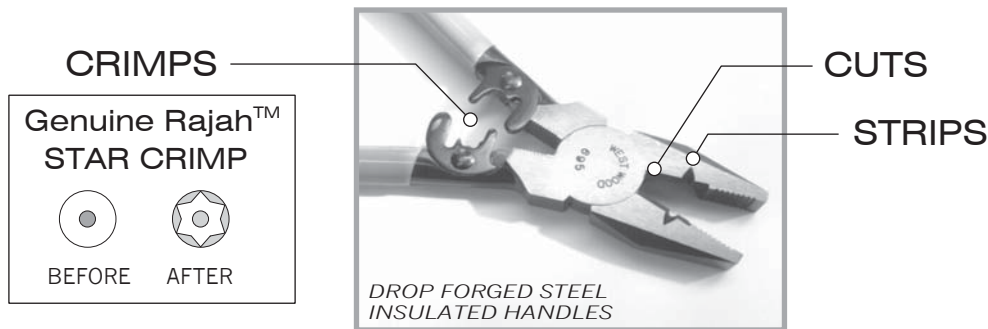

No.	Ref. No.	Description
T100-370	#997	Porcelain & gauge glass cutter, heavy duty chain, hardened wheels & jaws
T100-372	-	Replacement cutting chain for T100-370
T200-10	#695	Master Lineman's Pliers & Terminal Crimper, drop forged steel, 8-1/2" long

**Westwood**  
**CRIMPING TOOL**

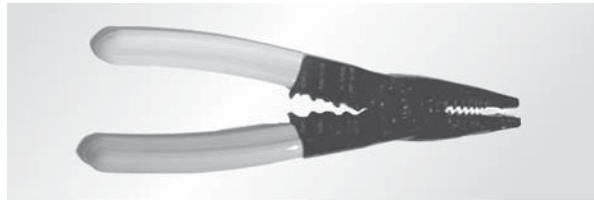

 No. T200-15

Cuts and strips #10 to #22 gage wire. Crimps standard insulated, non-insulated, and 7mm automotive type terminals. (for Rajah™ ignition terminals, see T200-10 Lineman's pliers and crimper on page T17)

**Westwood**  
**HEX KEY WRENCH SETS**

**HEAT TREATED!**

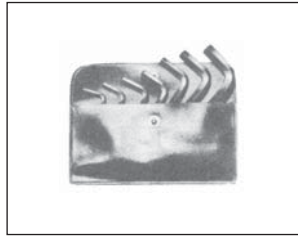

 No. T200-50

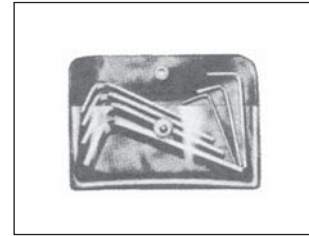

 No. T200-52

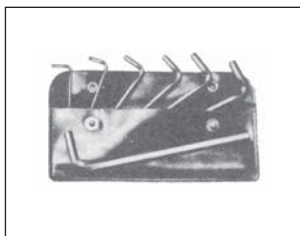

 No. T200-54

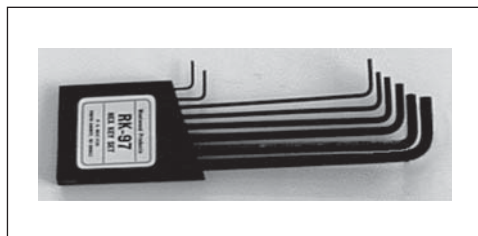

 No. T200-56



 No. T200-58

**Westwood**  
**CIRCULATOR FLANGE TOOL**

For installing popular B&G and Taco circulator flanges on pipe. Use with a socket or wrench.

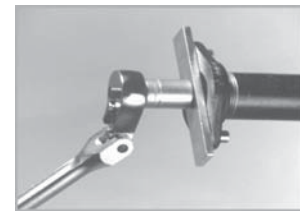

 No. T200-80

 No.	Ref. No.	Description
T200-15	#271	Cutting - Crimping - Stripping tool, for standard wire terminals
T200-50	LK-66	Long hex key set in pouch, 5/64", 3/32", 1/8", 5/32", 3/16", 7/32", 1/4"
T200-52	SK-59	Short hex key set in pouch, 5/64", 3/32", 1/8", 5/32", 3/16", 7/32", 1/4"
T200-54	XK104	6" long hex key set in pouch, 5/64", 3/32", 1/8", 5/32", 3/16", 7/32", 1/4"
T200-56	RK-97	Hex key set in case, .050, 1/16", 5/64", 3/32", 1/8", 5/32", 3/16", 7/32"
T200-58	HK-17	Folding hex key set, .050, 1/16", 5/64", 3/32", 1/8", 5/32", 3/16"
T200-80	FT-1	Circulator flange installation tool, square drive